



**ZHEJIANG HANGCHA IMP. & EXP. CO., LTD.**

**Factory site:** 666 Xiangfu Road,  
Hangzhou, Zhejiang, China (311305)

Tel: +86-571-88926735 88926755  
Fax: +86-571-88926789 88132890

sales@hcforklift.com  
www.hcforklift.com



Follow us on  
Facebook



Follow us on  
YouTube



Follow us on  
WeChat



ISO14001  
ISO14001:2015



ISO9001  
ISO9001:2015



HANGCHA trucks conform  
to the European Safety  
Requirements.

2020 VERSION 1 / COPYRIGHT 2020/04

HANGCHA GROUP CO., LTD. reserves the right to make any changes without notice concerning colors, equipment, or specifications detailed in this brochure, or to discontinue individual models. The colors of trucks, delivered may differ slightly from those in brochures.



## XF Series Diesel / LPG Counterbalanced Trucks

with capacities of 5,000 to 7,000kg

*The World of Hangcha*



# HANGCHA be with you at every stage

Efficient, reliable solutions for your demands

## STAGE V

With Hangcha you can meet all Stage V emissions standards which provides customer demands for value, innovation and performance. The technologies include common rail fuel systems, turbocharged Inter-cooled ,EGR + DOC + DPF. Designed and optimised to every engine model, our forklift truck maximises efficiency and reliability.

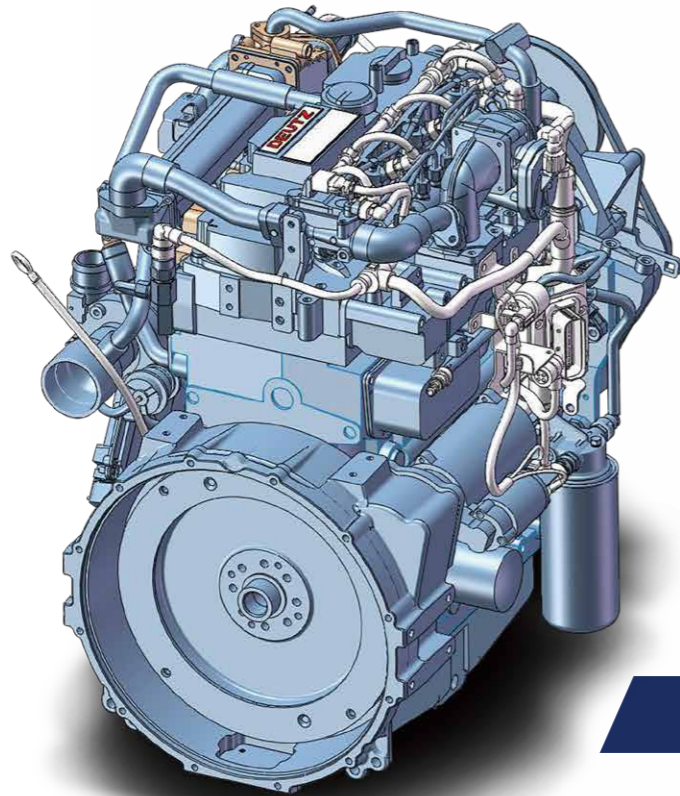

**DEUTZ**



Interactive instrument: The instrument adopts 4.0-inch color LCD display with four interactive buttons, and has one CAN bus communication function. The communication protocol is compatible with CANopen and SAE J1939 standards.

**Powerful/  
Efficient/  
Reliable**



### HANGCHA Forklift with StageV

No.	Capacity	Series	Manufacturer	Engine	Drive power	Model	Emission Std.	Transmission	Power (kw/rpm)	Service brake
1	5.0-7.0t	XF	DEUTZ	TCD 3.6 L4 EU Stage V	Diesel	CPCD50/60/70-XW95G	Stage V	ZF	55.4/2300	Wet brake

Note: Stage V applied for European Union also including Israel and Turkey

# Comfortable Operation



The extra foot space is provided to reduce operator fatigue significantly. The new wide-open, non-slip step makes getting in and out easy and safe.

The optional Electro-hydraulic proportional control system contributes more sensitive and precise load handling. The easy-to-operate levers provide total load handling operation. An armrest is provided to reduce fatigue.

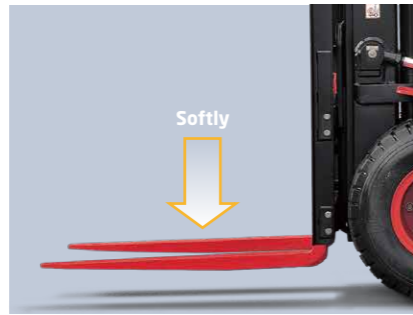

In addition to the soft landing system, the soft lifting system is adopted (front lifting cylinders of triplex mast and full free duplex mast), as a result, the noise and shock of the mast significantly decreases.

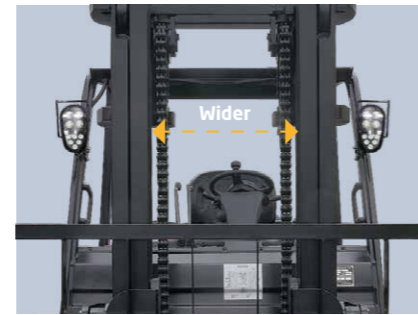

The new design mast provides broad forward visibility due to the distance between inside mast is increase 60mm.

# Productivity

Thanks to the series technological innovations, the efficiency of the truck is improved, the energy consumption is reduced.



*By optimizing transmission design, the power train provides higher efficiency, and the Max. driving speed is increased **20%***



The new efficiency LED lighting system and new type reflector reduce energy consumption, improve illumination performance and prolong working life.

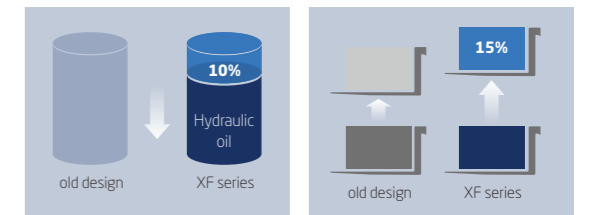

The new patent dynamic load sensing hydraulic steering system contributes to reduce loss of hydraulic, improve energy consumption and increase 15% lifting speed.



*In developing the XF 5-7t series, comfort and easy operation is always considered, for example, improved vibrating levels, compound engine damper and full floating seat and cabin are applied. Comfortable also contribute to increased productivity.*



1. The new, relocated easy-to-see LCD meter lets the operator check on all aspects of operational status at a glance.
2. The new automobile-style light/turn-signal lever and forward-reverse lever are ergonomically designed and arranged to improve comfort and productivity.
3. Only 90N parking brake force is required.
4. The small diameter steering wheel with tilt adjustment provides the ideal operating position. The superior responsiveness of the steering wheel optimizes maneuverability even in narrow spaces.
5. The automobile-style suspended pedals provide more ergonomic operation.



# Reliability

By focusing on enhancing reliability, reducing downtime, the XF series is able to make the greater productivity for customer.



The new stamped air cleaner featuring tangential intake, double seal with safety filter is durable, corrosion-free and vibration-resistant, provides better filter efficiency and lower intake resistance than the previous.

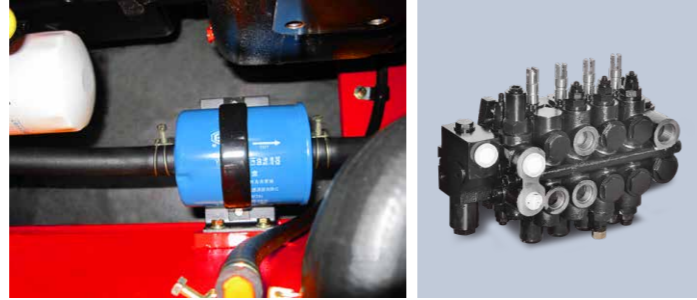

Brake oil and steering oil are separated, non-interference in each other, using dynamic load sensing steering system, more energy efficient.

The patent plated-fin type aluminum radiator is applied, the heat exchanging is approved, and improves the capability for operation in severe environments.



There're four levels shock absorption applied to reduced the vibration from the road to the driver. The damping pad is applied reduce the vibration, Like between the steering axle and the chassis, The engine, torque convertor and the chassis, the overhead guard and the chassis. And the suspension seat is another vibration reduction.



High strength chassis, mast and front/rear axle are to make sure the reliability of the truck, even for high strength application.

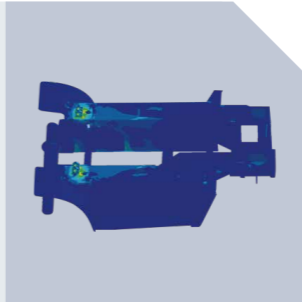

All the controllers, relays, and safety fuses are allocated in the controller box, free to water and dust. The main electronic components are waterproof, which is capable operator in severe environment. And the famous brand air-filter is also applied in the truck.



# Easy Maintenance

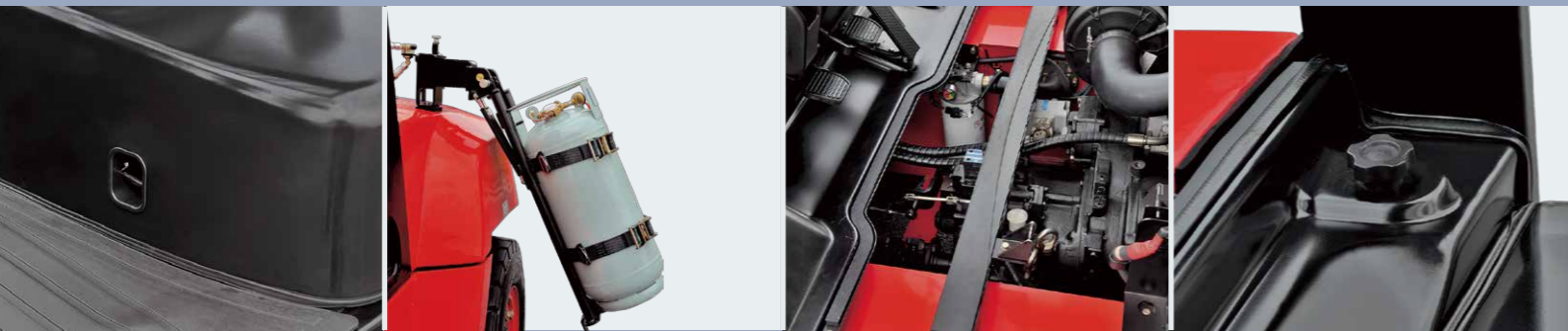

Careful design facilitates inspection and servicing. Easy maintenance reduces the amount of downtime and helps to reduce cost also.

The location of the air-filter is easy to reach, and it's very easy to replace the filter.

The rotating LPG bottle holder is easy to replace the bottle, reduces the downtime.

All the locations of the engine oil level dipstick, filter of hydraulic, water separator are easy to reach, and very easy for engineer to check.

There's gas spring support for the front cover of radiator, and it can auto-open when the rear cover of radiator is opened.

# Safety

A wide range of technologies are applied to ensure absolute safety for both the operator and those in the surrounding.



There's an energy accumulator applied in the braking system, which means when the engine is shut down, it can also provide more than 4 times emergency brake.

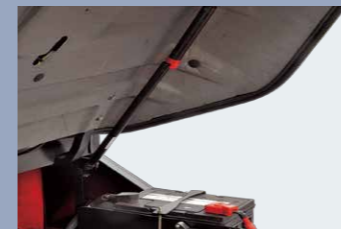

The locking device of the engine hood damper and parking brake help add to safety.



1. The seat sensor system incorporates lifting/tilting and traveling locking function. When the operator leaves the seat, the system automatically locks lifting/tilting and disables traveling to ensure safety.
2. A throttling device is adopted to avoid the mast being out of control even some pipes are broken.

# Standards

Transmission	Steering	Chassiss	Control	Hydraulic
<ul style="list-style-type: none"> <li>/ Suspension transmission</li> <li>/ Oil filter</li> <li>/ Dipstick</li> <li>/ Oil cooler</li> <li>/ Non-asbestos bake</li> <li>/ Wet brake (W65/W95)</li> </ul>	<ul style="list-style-type: none"> <li>/ Full hydraulic power steering</li> <li>/ Smaller diameter steering wheel</li> <li>/ Adjuster of steering wheel</li> </ul>	<ul style="list-style-type: none"> <li>/ Skidproof pedal</li> <li>/ Rubber pedal</li> <li>/ Engine hood spring</li> </ul>	<ul style="list-style-type: none"> <li>/ Power steering</li> <li>/ Suspension pedal</li> <li>/ Integrated combination switch</li> <li>/ Parking brake</li> </ul>	<ul style="list-style-type: none"> <li>/ Dynamic load sending control valve</li> <li>/ Hydraulic oil filter</li> <li>/ Tilt cylinder self-lock valve</li> <li>/ Hydraulic oil dipstick</li> <li>/ Accumulator</li> </ul>

Truck	Power	Electronics	Mast
<ul style="list-style-type: none"> <li>/ Traction device</li> <li>/ Hand grip</li> <li>/ Standard seat</li> <li>/ Standard overhead guard</li> <li>/ Waterproof cover on the guard</li> <li>/ Back view mirror</li> <li>/ Pneumatic tyres</li> <li>/ Toolbox</li> </ul>	<ul style="list-style-type: none"> <li>/ Big capacity aluminum radiator</li> <li>/ Whirlwind air cleaner</li> <li>/ Safety filter</li> <li>/ High-efficient intake muffler</li> <li>/ High-efficient exhaust muffler</li> <li>/ Middle-positioned exhaust system</li> <li>/ High-positioned exhaust system (W95)</li> </ul>	<ul style="list-style-type: none"> <li>/ High-efficient front lights</li> <li>/ High-efficient LED rear lights</li> <li>/ Service-free start battery</li> <li>/ Combination controller</li> <li>/ LCD display</li> <li>/ Neutual switch</li> <li>/ Hour meter</li> <li>/ Fuel gauge</li> <li>/ Water temperature gauge</li> </ul>	<ul style="list-style-type: none"> <li>/ Pre-heat indicator</li> <li>/ Charging indicator</li> <li>/ Engine fuel pressure warning</li> <li>/ Oil temperature</li> <li>/ Horn</li> <li>/ Reversing buzzer</li> <li>/ Air-filter with jam sensor</li> <li>/ Emergency power off</li> </ul>



# Options

Truck	Transmission	Power	Hydraulic	Electronics	Mast
<ul style="list-style-type: none"> <li>/ Cabin</li> <li>/ Cabin heater</li> <li>/ Front window</li> <li>/ Super elastic tyre</li> <li>/ Non-mark tyre(white/green)</li> <li>/ Suspension seat</li> <li>/ Extinguisher</li> <li>/ Special given color</li> <li>/ Boot for tilt cylinder</li> <li>/ Counter weight net</li> <li>/ Seat sensor system</li> </ul>	<ul style="list-style-type: none"> <li>/ Japanese drum brake</li> <li>/ Wet brake</li> </ul>	<ul style="list-style-type: none"> <li>/ Upright exhaust system</li> <li>/ Air pre-cleaner</li> <li>/ Net cover of radiator</li> <li>/ Spark arrester</li> <li>/ Purified exhaust system</li> <li>/ Fan protector</li> </ul>	<ul style="list-style-type: none"> <li>/ Auxiliary hydraulic valve</li> <li>/ Elecctro-hydraulic</li> <li>/ Proportional control system</li> </ul>	<ul style="list-style-type: none"> <li>/ OBD</li> <li>/ Front working light</li> <li>/ Rear working light</li> <li>/ Warning lamp</li> </ul>	<ul style="list-style-type: none"> <li>/ Duplex wide view free-lift mast</li> <li>/ Triplex wide view free-lift mast</li> <li>/ Special forks</li> <li>/ Wider fork carriage</li> <li>/ Widerload back rest</li> </ul>

# Optional Attachments

- / Paper roll clamp
- / Rotating bale clamp
- / Load stabilizer
- / Multi-drum clamp
- / Bale clamp
- / Drum clamp
- / Dumping clamp
- / Crane arm
- / String Pole
- / Sideshifter
- / Rotating forks
- / Fork extensioener
- / Load release device
- / Carton clamp
- / Push-pull device
- / Bucket
- / Hook
- / Lengthened fork



## 5.0~7.0t XF series mast: (pneumatic)

Type	Model	Max. fork height mm	Overall height				Free lift		Load distance, centre of drive axle to fork mm	Tilt range FWD/BWD (°)	Capacity Load capacity at 600mm Double tire		
			Lowered mm	Extended		Without backrest mm	With backrest mm	5.0t kg			6.0t kg	7.0t kg	
				Without backrest mm	With backrest mm								
Wide view mast	X50/70M250	2500	2250	3495/3667	3907	160	160	598.5/603.5	6/12	5000	6000	7000	
	X50/70M270	2700	2350	3695/3867	4107	160	160	598.5/603.5	6/12	5000	6000	7000	
	X50/70M300	3000	2500	3995/4167	4407	160	160	598.5/603.5	6/12	5000	6000	7000	
	X50/70M330	3300	2650	4295/4467	4707	160	160	598.5/603.5	6/12	5000	6000	7000	
	X50/70M360	3600	2800	4595/4767	5007	160	160	598.5/603.5	6/12	5000	6000	7000	
	X50/70M400	4000	3000	4995/5167	5407	160	160	598.5/603.5	6/12	5000	6000	7000	
	X50/70M430	4300	3200	5300/5467	5707	160	160	598.5/603.5	6/6	5000	6000	7000	
	X50/70M450	4500	3300	5500/5667	5907	160	160	598.5/603.5	6/6	5000	6000	7000	
	X50/70M480	4800	3450	5800/5967	6207	160	160	598.5/603.5	6/6	5000	6000	7000	
	X50/70M500	5000	3550	6000/6167	6407	160	160	598.5/603.5	6/6	5000	6000	7000	
Wide view full free duplex mast	X50/70M550	5500	3850	6550/6667	6907	160	160	598.5/603.5	3/6	4750	5700	6600	
	X50/70M600	6000	4100	7050/7167	7407	160	160	598.5/603.5	3/6	4450	5400	6400	
	X50/70U250	2500	2185	3455/3615	3637	1230/1070	1048	625.5/631.5	6/12	5000	6000	7000	
	X50/70U270	2700	2300	3655/3815	3837	1345/1185	1163	625.5/631.5	6/12	5000	6000	7000	
	X50/70U300	3000	2450	3955/4115	4137	1495/1335	1313	625.5/631.5	6/12	5000	6000	7000	
	X50/70U330	3300	2600	4255/4415	4437	1645/1485	1463	625.5/631.5	6/12	5000	6000	7000	
Wide view full free triplex mast	X50/70U360	3600	2750	4555/4715	4737	1795/1635	1613	625.5/631.5	6/12	5000	6000	7000	
	X50/70U400	4000	2950	4955/5115	5137	1995/1835	1813	625.5/631.5	6/12	5000	6000	7000	
	X50/70N450	4500	2725	5735	5907	1500	1328	667/672	6/6	4500	5600	6400	
	X50/70N480	4800	2825	6035	6207	1600	1428	667/672	6/6	4500	5600	6300	
	X50/70N500	5000	2875	6213	6407	1672	1478	667/672	6/6	4500	5500	6300	
	X50/70N550	5500	3075	6785	6907	1800	1678	667/672	3/6	4200	5200	6100	
	X50/70N600	6000	3225	7235	7407	2000	1828	667/672	3/6	4000	5000	5500	
X50/70N700	7000	3675	8385	8407	2300	2278	667/672	3/6	2900	3300	3800		

With sideshifter minus 500Kg,with integral sideshifter minus 400kg.

# XF series 5.0~7.0t forklift specification :

		HANGCHA GROUP CO.,LTD.													
Distinguishing mark	1.1	Manufacturer	HANGCHA GROUP CO.,LTD.												
	1.2	Manufacturer's type designation	CPCD50-XW38	CPCD60-XW38	CPCD70-XW38	CPCD50-XW14	CPCD60-XW14	CPCD70-XW14	CPCD50-XW41	CPCD60-XW41	CPCD70-XW41	CPYD50-XW57	CPYD60-XW57	CPYD70-XW57	
	1.3	Drive: electric (battery or mains), diesel, petrol, fuel gas	Diesel	Diesel	Diesel	Diesel	Diesel	Diesel	Diesel	Diesel	Diesel	LPG	LPG	LPG	
	1.4	Operator type: hand, pedestrian, standing, seated, order-picker	Seat	Seat	Seat	Seat	Seat	Seat	Seat	Seat	Seat	Seat	Seat	Seat	
	1.5	Rated capacity/rated load	Q (kg)	5000	6000	7000	5000	6000	7000	5000	6000	7000	5000	6000	7000
	1.6	Load centre distance	c(mm)	600	600	600	600	600	600	600	600	600	600	600	600
	1.8	Load distance, centre of drive axle to fork	x(mm)	598.5	598.5	603.5	598.5	598.5	603.5	598.5	598.5	603.5	598.5	598.5	603.5
	1.9	Wheelbase	y(mm)	2300	2300	2300	2300	2300	2300	2300	2300	2300	2300	2300	2300
	Weight	2.1	Service weight	kg	7950	8480	9250	8050	8580	9350	8050	8580	9350	7950	8480
2.2		Axle loading, laden front/rear	kg	11270/1680	12770/1710	14600/1650	11350/1700	12850/1730	14600/1750	11350/1700	12850/1730	14600/1750	11270/1680	12770/1710	14600/1650
2.3		Axle loading, unladen front/rear	kg	3850/4100	3730/4750	3680/5570	3900/4150	3770/4810	3720/5630	3900/4150	3770/4810	3720/5630	3850/4100	3730/4750	3680/5570
Tyres, chassis	3.1	Tyres: solid rubber, superelastic, pneumatic, polyurethane	pneumatic	pneumatic	pneumatic	pneumatic	pneumatic	pneumatic	pneumatic	pneumatic	pneumatic	pneumatic	pneumatic	pneumatic	
	3.2	Tyre size, front	8.25-15-14PR	8.25-15-14PR	8.25-15-14PR	8.25-15-14PR	8.25-15-14PR	8.25-15-14PR	8.25-15-14PR	8.25-15-14PR	8.25-15-14PR	8.25-15-14PR	8.25-15-14PR	8.25-15-14PR	
	3.3	Tyre size, rear	8.25-15-14PR	8.25-15-14PR	8.25-15-14PR	8.25-15-14PR	8.25-15-14PR	8.25-15-14PR	8.25-15-14PR	8.25-15-14PR	8.25-15-14PR	8.25-15-14PR	8.25-15-14PR	8.25-15-14PR	
	3.5	Wheels , number front rear (x = driven wheels)	4x/2	4x/2	4x/2	4x/2	4x/2	4x/2	4x/2	4x/2	4x/2	4x/2	4x/2	4x/2	
	3.6	Tread, front	b <sub>10</sub> (mm)	1489	1489	1489	1489	1489	1489	1489	1489	1489	1489	1489	
	3.7	Tread, rear	b <sub>11</sub> (mm)	1700	1700	1700	1700	1700	1700	1700	1700	1700	1700	1700	
	Dimensions	4.1	Tilt of mast/fork carriage forward/backward	α/β(°)	6/12	6/12	6/12	6/12	6/12	6/12	6/12	6/12	6/12	6/12	6/12
4.2		Height, mast lowered	h <sub>1</sub> (mm)	2500	2500	2500	2500	2500	2500	2500	2500	2500	2500	2500	
4.3		Free lift	h <sub>2</sub> (mm)	160	160	160	160	160	160	160	160	160	160	160	
4.4		Lift	h <sub>3</sub> (mm)	3000	3000	3000	3000	3000	3000	3000	3000	3000	3000	3000	
4.5		Height, mast extended	h <sub>4</sub> (mm)	4420	4420	4420	4420	4420	4420	4420	4420	4420	4420	4420	
4.7		Height of overhead guard	h <sub>6</sub> (mm)	2430	2430	2430	2430	2430	2430	2430	2430	2430	2430	2430	
4.8		Seat height	h <sub>7</sub> (mm)	1350	1350	1350	1350	1350	1350	1350	1350	1350	1350	1350	
4.12		Coupling height	h <sub>10</sub> (mm)	430	430	430	430	430	430	430	430	430	430	430	
4.19		Overall length	l <sub>1</sub> (mm)	4699	4729	4804	4699	4729	4804	4699	4729	4804	4699	4729	4804
4.20		Length to face of forks	l <sub>2</sub> (mm)	3499	3529	3604	3499	3529	3604	3499	3529	3604	3499	3529	3604
4.21		Overall width	b <sub>1</sub> (mm)	1995	1995	1995	1995	1995	1995	1995	1995	1995	1995	1995	
4.22		Fork dimensions	s/e/l (mm)	60x150x1200	60x150x1200	65x150x1200	60x150x1200	60x150x1200	65x150x1200	60x150x1200	60x150x1200	65x150x1200	60x150x1200	60x150x1200	65x150x1200
4.23		Fork carriage DIN 15173, class/type A, B		IV A	IV A	IV A	IV A	IV A	IV A	IV A	IV A	IV A	IV A	IV A	
4.24		Fork-carriage width	b <sub>3</sub> (mm)	1700	1700	1700	1700	1700	1700	1700	1700	1700	1700	1700	
4.31		Ground clearance, laden, mast	m <sub>1</sub> (mm)	190	190	190	190	190	190	190	190	190	190	190	
4.32		Ground clearance, centre of wheelbase	m <sub>2</sub> (mm)	270	270	270	270	270	270	270	270	270	270	270	
4.34.1		Aisle width for pallets 1000 x 1200 crossways	A <sub>st</sub> (mm)	5030	5080	5150	5030	5080	5150	5030	5080	5150	5030	5080	5150
4.34.2		Aisle width for pallets 800 x 1200 lengthways	A <sub>st</sub> (mm)	5230	5280	5350	5230	5280	5350	5230	5280	5350	5230	5280	5350
4.35		Turning radius	W <sub>a</sub> (mm)	3230	3280	3350	3230	3280	3350	3230	3280	3350	3230	3280	3350
4.36		Internal turning radius	b <sub>13</sub> (mm)	1222	1222	1222	1222	1222	1222	1222	1222	1222	1222	1222	
Performance data	5.1	Travel speed, laden/unladen	km/h	27.8/29	27.8/29	25.5/29	28.0/30	28.0/30	25.6/30	28.0/30	28.0/30	25.6/30	29.8/31	28.1/31	27.1/31
	5.2	Lift speed, laden/unladen	m/s	0.488/0.518	0.488/0.518	0.4200/0.460	0.550/0.580	0.550/0.580	0.500/0.530	0.550/0.580	0.550/0.580	0.500/0.530	0.4320/0.458	0.432/0.458	0.382/0.405
	5.3	Lowering speed, laden/unladen	m/s	0.480/0.420	0.480/0.420	0.480/0.420	0.480/0.420	0.480/0.420	0.480/0.420	0.480/0.420	0.480/0.420	0.480/0.420	0.480/0.420	0.480/0.420	0.480/0.420
	5.5	Drawbar pull,laden/unladen	N	65000/25440	65000/26720	65000/27500	84000/25440	84000/26720	84000/27500	84000/25440	84000/26720	84000/27500	50000/25440	50000/26720	50000/27500
	5.7	Gradeability, laden/unladen	%	48/20	43/20	36/20	48/20	43/20	36/20	48/20	43/20	36/20	38/20	33/20	27/20
	5.10	Service brake		Hydraulic	Hydraulic	Hydraulic	Hydraulic	Hydraulic	Hydraulic	Hydraulic	Hydraulic	Hydraulic	Hydraulic	Hydraulic	Hydraulic
Combustion-engine	7.1	Engine manufacturer/type	Cummins QSB3.3-C99	Cummins QSB3.3-C99	Cummins QSB3.3-C99	ISUZU 6BG1QP	ISUZU 6BG1QP	ISUZU 6BG1QP	ISUZU 6BG1TRC	ISUZU 6BG1TRC	ISUZU 6BG1TRC	GM 4.3L	GM 4.3L	GM 4.3L	
		Emission standard	Stage III A	Stage III A	Stage III A	Stage I	Stage I	Stage I	Stage II	Stage II	Stage II	-	-	-	
	7.2	Engine power according to DIN ISO 1585	kW	74	74	74	84.6	84.6	84.6	97.7	97.7	97.7	74	74	74
	7.3	Rated speed	r/min	2200	2200	2200	2200	2200	2200	2200	2200	2200	2300	2300	2300
7.4	No. of cylinders/displacement	(-)/ (cm <sup>3</sup> )	4/3300	4/3300	4/3300	6/6494	6/6494	6/6494	6/6494	6/6494	6/6494	V6/4300	V6/4300	V6/4300	
Addition data	10.1	Operating pressure for attachments	bar	190	190	190	190	190	190	190	190	190	190	190	
	10.2	Oil volume for attachments	l/min	120	120	120	120	120	120	120	120	120	120	120	
	10.8	Towing coupling,type DIN 15170		Pin	Pin	Pin	Pin	Pin	Pin	Pin	Pin	Pin	Pin	Pin	

Note: \* aisle width calculation based on VDI 2198

# XF series 5.0~7.0t forklift specification :

		HANGCHA GROUP CO.,LTD.														
Distinguishing mark	1.1	Manufacturer	HANGCHA GROUP CO.,LTD.													
	1.2	Manufacturer's type designation	CPYD50-XW68	CPYD60-XW68	CPYD70-XW68	CPYD50-XW24	CPYD60-XW24	CPYD70-XW24	CPCD50-XW65G	CPCD60-XW65G	CPCD70-XW65G	CPCD50-XW95G	CPCD60-XW95G	CPCD70-XW95G		
	1.3	Drive: electric (battery or mains), diesel, petrol, fuel gas	LPG	LPG	LPG	LPG	LPG	LPG	Diesel	Diesel	Diesel	Diesel	Diesel	Diesel		
	1.4	Operator type: hand, pedestrian, standing, seated, order-picker	Seat	Seat	Seat	Seat	Seat	Seat	Seat	Seat	Seat	Seat	Seat	Seat		
	1.5	Rated capacity/rated load	Q (kg)	5000	6000	7000	5000	6000	7000	5000	6000	7000	5000	6000		
	1.6	Load centre distance	c(mm)	600	600	600	600	600	600	600	600	600	600	600		
	1.8	Load distance, centre of drive axle to fork	x(mm)	598.5	598.5	603.5	598.5	598.5	603.5	598.5	598.5	603.5	598.5	603.5		
	1.9	Wheelbase	y(mm)	2300	2300	2300	2300	2300	2300	2300	2300	2300	2300	2300		
	Weight	2.1	Service weight	kg	7950	8480	9250	7950	8480	9250	8000	8530	9300	8000	8530	
2.2		Axle loading, laden front/rear	kg	11270/1680	12770/1710	14600/1650	11270/1680	12770/1710	14600/1650	11290/1710	12790/1740	14620/1680	11290/1710	12790/1740		
2.3		Axle loading, unladen front/rear	kg	3850/4100	3730/4750	3680/5570	3850/4100	3730/4750	3680/5570	3870/4130	3750/4780	3700/5600	3870/4130	3750/4780		
Tyres, chassis	3.1	Tyres: solid rubber, superelastic, pneumatic, polyurethane	pneumatic	pneumatic	pneumatic	pneumatic	pneumatic	pneumatic	pneumatic	pneumatic	pneumatic	pneumatic	pneumatic	pneumatic		
	3.2	Tyre size, front	8.25-15-14PR	8.25-15-14PR	8.25-15-14PR	8.25-15-14PR	8.25-15-14PR	8.25-15-14PR	8.25-15-14PR	8.25-15-14PR	8.25-15-14PR	8.25-15-14PR	8.25-15-14PR	8.25-15-14PR		
	3.3	Tyre size, rear	8.25-15-14PR	8.25-15-14PR	8.25-15-14PR	8.25-15-14PR	8.25-15-14PR	8.25-15-14PR	8.25-15-14PR	8.25-15-14PR	8.25-15-14PR	8.25-15-14PR	8.25-15-14PR	8.25-15-14PR		
	3.5	Wheels , number front rear (x = driven wheels)	4x/2	4x/2	4x/2	4x/2	4x/2	4x/2	4x/2	4x/2	4x/2	4x/2	4x/2	4x/2		
	3.6	Tread, front	b <sub>10</sub> (mm)	1489	1489	1489	1489	1489	1489	1489	1489	1489	1489	1489		
	3.7	Tread, rear	b <sub>11</sub> (mm)	1700	1700	1700	1700	1700	1700	1700	1700	1700	1700	1700		
	Dimensions	4.1	Tilt of mast/fork carriage forward/backward	α/β(°)	6/12	6/12	6/12	6/12	6/12	6/12	6/12	6/12	6/12	6/12	6/12	
4.2		Height, mast lowered	h <sub>1</sub> (mm)	2500	2500	2500	2500	2500	2500	2500	2500	2500	2500	2500		
4.3		Free lift	h <sub>2</sub> (mm)	160	160	160	160	160	160	160	160	160	160	160		
4.4		Lift	h <sub>3</sub> (mm)	3000	3000	3000	3000	3000	3000	3000	3000	3000	3000	3000		
4.5		Height, mast extended	h <sub>4</sub> (mm)	4420	4420	4420	4420	4420	4420	4420	4420	4420	4420	4420		
4.7		Height of overhead guard	h <sub>6</sub> (mm)	2430	2430	2430	2430	2430	2430	2430	2430	2430	2430	2430		
4.8		Seat height	h <sub>7</sub> (mm)	1350	1350	1350	1350	1350	1350	1350	1350	1350	1350	1350		
4.12		Coupling height	h <sub>10</sub> (mm)	430	430	430	430	430	430	430	430	430	430	430		
4.19		Overall length	l <sub>1</sub> (mm)	4699	4729	4804	4699	4729	4804	4699	4729	4804	4699	4729		
4.20		Length to face of forks	l <sub>2</sub> (mm)	3499	3529	3604	3499	3529	3604	3499	3529	3604	3499	3529		
4.21		Overall width	b <sub>1</sub> (mm)	1995	1995	1995	1995	1995	1995	1995	1995	1995	1995	1995		
4.22		Fork dimensions	s/e/l (mm)	65x150x1200	65x150x1200	65x150x1200	60x150x1200	60x150x1200	65x150x1200	60x150x1200	60x150x1200	65x150x1200	60x150x1200	60x150x1200		
4.23		Fork carriage DIN 15173, class/type A, B		IV A	IV A	IV A	IV A	IV A	IV A	IV A	IV A	IV A	IV A	IV A		
4.24		Fork-carriage width	b <sub>3</sub> (mm)	1700	1700	1700	1700	1700	1700	1700	1700	1700	1700	1700		
4.31		Ground clearance, laden, mast	m <sub>1</sub> (mm)	190	190	190	190	190	190	190	190	190	190	190		
4.32		Ground clearance, centre of wheelbase	m <sub>2</sub> (mm)	270	270	270	270	270	270	270	270	270	270	270		
4.34.1		Aisle width for pallets 1000 x 1200 crossways	A <sub>st</sub> (mm)	5030	5080	5150	5030	5080	5150	5030	5080	5150	5030	5080		
4.34.2		Aisle width for pallets 800 x 1200 lengthways	A <sub>st</sub> (mm)	5230	5280	5350	5230	5280	5350	5230	5280	5350	5230	5280		
4.35		Turning radius	W <sub>a</sub> (mm)	3230	3280	3350	3230	3280	3350	3230	3280	3350	3230	3280		
4.36		Internal turning radius	b <sub>13</sub> (mm)	1222	1222	1222	1222	1222	1222	1222	1222	1222	1222	1222		
Performance data	5.1	Travel speed, laden/unladen	km/h	29.8/31	28.1/31	27.1/31	29.8/31	28.1/31	27.1/31	24/28.3	23/28.3	22/28.3	24/28.3	23/28.3		
	5.2	Lift speed, laden/unladen	m/s	0.432/0.458	0.432/0.458	0.382/0.405	0.432/0.458	0.432/0.458	0.382/0.405	0.410/0.450	0.410/0.450	0.360/0.400	0.410/0.450	0.410/0.450		
	5.3	Lowering speed, laden/unladen	m/s	0.480/0.420	0.480/0.420	0.480/0.420	0.480/0.420	0.480/0.420	0.480/0.420	0.480/0.420	0.480/0.420	0.480/0.420	0.480/0.420	0.480/0.420		
	5.5	Drawbar pull,laden/unladen	N	50000/25440	50000/26720	50000/27500	50000/25440	50000/26720	50000/27500	63960/25440	64280/26720	65000/27500	63960/25440	64280/26720		
	5.7	Gradeability, laden/unladen	%	38/20	33/20	27/20	38/20	33/20	27/20	41/20	36/20	30/20	41/20	36/20		
	5.10	Service brake		Hydraulic	Hydraulic	Hydraulic	Hydraulic	Hydraulic	Hydraulic	Wet brake	Wet brake	Wet brake	Wet brake	Wet brake		
Combustion-engine	7.1	Engine manufacturer/type	PSI 4.3L(LPG)/NON-CERT	PSI 4.3L(LPG)/NON-CERT	PSI 4.3L(LPG)/NON-CERT	PSI 4.3L(LPG)/CERT	PSI 4.3L(LPG)/CERT	PSI 4.3L(LPG)/CERT	PSI 4.3L(LPG)/CERT	TCD3.6L4	TCD3.6L4	TCD3.6L4	TCD3.6L4			
		Emission standard	-	-	-	EPA Tier2	EPA Tier2	EPA Tier2	EPA Tier2	Stage III B	Stage III B	Stage III B	Stage V			
	7.2	Engine power according to DIN ISO 1585	kW	77	77	77	75	75	75	55.4	55.4	55.4	55.4			
	7.3	Rated speed	r/min	2300	2300	2300	2300	2300	2300	2300	2300	2300	2300			
7.4	No. of cylinders/displacement	(-)/ (cm <sup>3</sup> )	V6/4300	V6/4300	V6/4300	V6/4300	V6/4300	V6/4300	4/3621	4/3621	4/3621	4/3621				
Addition data	10.1	Operating pressure for attachments	bar	190	190	190	190	190	190	190	190	190	190			
	10.2	Oil volume for attachments	l/min	120	120	120	120	120	120	120	120	120	120			
	10.8	Towing coupling,type DIN 15170		Pin	Pin	Pin	Pin	Pin	Pin	Pin	Pin	Pin	Pin			

Note: \* aisle width calculation based on VDI 2198

